



# IPAQ-H / IPAQ-HX

## Universal Intelligent 2-wire In-head Transmitters

Actual size

IPAQ-H is a universal and intelligent 2-wire In-head transmitter for temperature and other measurement applications.

IPAQ-HX is the Intrinsic Safe version for use in Ex-applications.

The combination of *competitive pricing, functionality and simple configuration* has made IPAQ-H and IPAQ-HX leading in-head transmitters for industrial temperature measurements.



The Windows based and user friendly software, IPRO 4, is used for transmitter configuration, documentation, monitoring and calibration purposes.

### Performance and design:

#### Excellent stability

- Long-term stability 0.1 %/year.

#### Enhanced total system accuracy

- Sensor error correction (for known sensor errors).
- System error correction (against known temperatures).

#### NAMUR-compliant

- Output limitations and fail currents according to NAMUR recommendations.

#### Input-Output isolation 1500 VAC

- Eliminates measuring errors due to ground loops.

#### High load capacity

- Only 6.5 V voltage drop over the transmitter (IPAQ-H) allows for high loads.

#### Designed for harsh conditions

- Operation temperature: -40 to +85 °C, -40 to +185 °F.
- Excellent EMC performance.
- Durable, shockproof design.

#### Simple mounting and connection

- For DIN B head or larger.
- Large center hole (dia. 7 mm / 0.28 inch).

#### 5 year limited warranty

### Functions:

#### Input for RTDs, T/Cs, mV and resistance

- Reduced inventory costs.
- Simplified plant engineering.

#### True on-line communication

- Full access to all features while in operation.

#### Sensor diagnostics

- SmartSense detects low sensor isolation (essential for correct measurements).
- Selectable sensor break action.

#### Simplified loop check-up

- The transmitter works as an accurate current generator.

#### On-screen indications and line recording

- Valuable tools for temporary measurements.

## Main features of IPAQ-H and IPAQ-HX

### Accuracy and stability

IPAQ-H/IPAQ-HX are designed for applications with standard industrial demands on accuracy. To reach these demands, the following factors are essential:

**Linearity and calibration errors** -The use of quality components and precision calibration equipment reduce these errors, e.g.  $\pm 0.1\%$  of span for RTD inputs.

**High long-term stability** -Internal "self calibration", by means of continuous adjustment of important parameters after comparison with accurate built-in references, contributes to a stability of  $\pm 0.1\%$ /year.

### Measurements with RTDs and other resistances

IPAQ-H/IPAQ-HX accept inputs from standardized Platinum and Nickel RTDs like Pt10...Pt1000 acc. to IEC 751 ( $\alpha=0.00385$ ), Pt100 acc. to JIS 1604 ( $\alpha=0.003916$ ) and Ni100/Ni1000 acc. to DIN 43760, as well as inputs from plain resistance sensors such as potentiometers. 3- or 4-wire connection can be chosen.

### Measurements with thermocouples and plain voltage

IPAQ-H/IPAQ-HX accept inputs from 11 types of standardized thermocouples as well as plain mV input.

For T/C input, the CJC (cold junction compensation) is fully automatic, by means of an accurate measurement of the terminal temperature. Alternatively, the CJC can be disabled.

### Customized linearization and Engineering units

The *Customized linearization* can be used to create a linearization curve for RTD, T/C, resistance and mV inputs. By combining *Customized linearization* with the use of *Engineering units*, the transmitters can be programmed to give a linear output corresponding to a specific measuring range expressed in the primary process value. The sensor characteristics are described by a maximum of 9 data pairs. Fig. 1a and 1b.

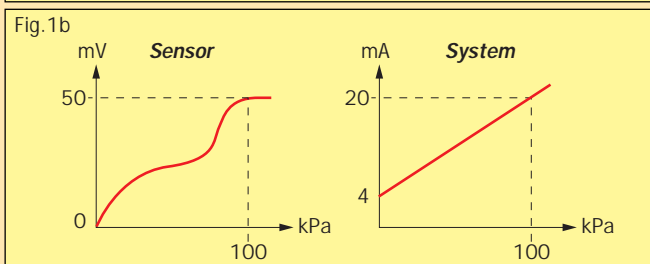
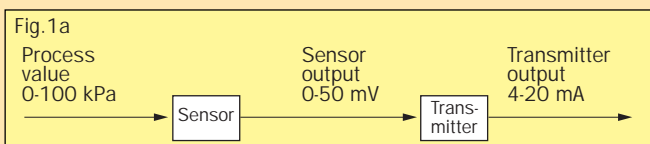

Example of a system (sensor + transmitter) with an output **linear** to the process value, in spite of a **non-linear** sensor.

### Sensor or System error correction

IPAQ-H/IPAQ-HX offer two ways of improving the measurement with temperature sensors:

**Sensor error correction** - Known sensor errors compared to the standard curve, e.g. for a calibrated sensor, are entered, and the transmitter automatically corrects for the sensor errors. Fig. 2.

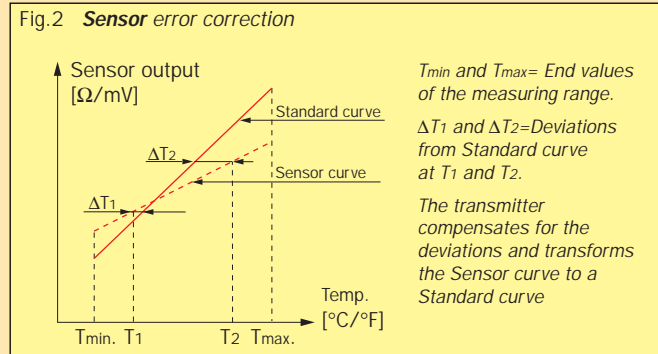

**System error correction** -This method is used to correct the system error (sensor + transmitter error) by exposing the sensor to one (one-point correction) or two (two-point correction) accurately measured temperatures (true temperatures). The true temperature(s) are entered, and the transmitter automatically corrects for the system errors. Fig. 3.

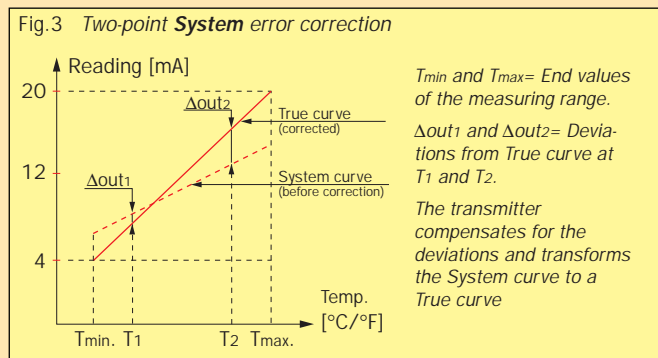

### SmartSense - Sensor isolation monitoring

SmartSense continuously monitors the isolation resistance of thermocouples and 3-wire connected RTDs as well as the cabling between sensor and transmitter. The transmitter will react by forcing the output to a user defined level if the isolation is too low. SmartSense requires an extra lead inside the thermocouple or RTD. Fig. 5.

For detailed information, see section Theory and Facts.

### Sensor break monitoring

IPAQ-H/IPAQ-HX monitor sensor break and force the output signal to a user defined level, when *any* sensor lead is broken or disconnected. The sensor break monitoring can be switched off. The monitoring is furnished with a *pulsed excitation current*. This eliminates the voltage drop in the lead wires (giving a measuring error), caused by a standard DC excitation current.

### Controlled output for instrument calibration

IPAQ-H/IPAQ-HX can be set to automatically provide a recurring output current regardless of the input signal. The total time for the controlled output is adjustable up to 30 minutes.

**Dampening**

The dampening function can be used to dampen undesired instabilities on the input signal. The dampening time is approximately 2 seconds. The dampening time, is the time required, in addition to the update time, for the output to reach 90% of its final value after a step change has been applied to the input.

**Power supply**

IPAQ-H/IPAQ-HX are loop-powered and will work on voltages down to 6.5 VDC (8 VDC for IPAQ-HX), thus giving good margins for high loads in the current loop. Reversed polarity will not damage the transmitter. Fig. 6

**Mounting**

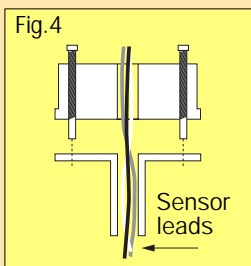

IPAQ-H/IPAQ-HX are designed to fit inside connection heads type DIN B or larger.

The large center hole, dia. 7 mm / 0.28 inch, facilitates the pulling through of the sensor leads or an insert tube, greatly simplifying the mounting procedure. Fig. 4.

**Warranty**

IPAQ-H/IPAQ-HX are covered by a 5 year limited warranty.

**IPRO 4 - The user friendly software for all transmitters of the IPAQ family**

IPRO 4, which is used with all IPAQ-transmitters, is the tool to utilize all the versatile functions of the IPAQ-H/IPAQ-HX such as:

- Measurement configuration: Sensor type, range, sensor or system error correction, linearization, engineering units, output settings, filter activation, etc.
- Monitoring of sensor status: Sensor break and sensor isolation (SmartSense).
- On-screen real time presentation of measured values and output signal in the form of numericals, meters, bar graphs and line recorder.
- Transmitter calibration: Field calibration in one or two points and basic calibration.
- Documentation: Configuration files can be saved for future use and configuration protocols can easily be printed.

The communication with the transmitter can be performed on line, i.e. with transmitter in operation. An isolated and Ex-approved communication cable is included in the software kit, IPRO-X.

IPRO 4 is compatible with Windows 3.1, Windows 3.11, Windows 95 and Windows NT Workstation 4.0. The program is menu-driven and easy to learn. On-line help is an effective tool for the user.

**IPAQ-H/IPAQ-HX Configuration scheme**

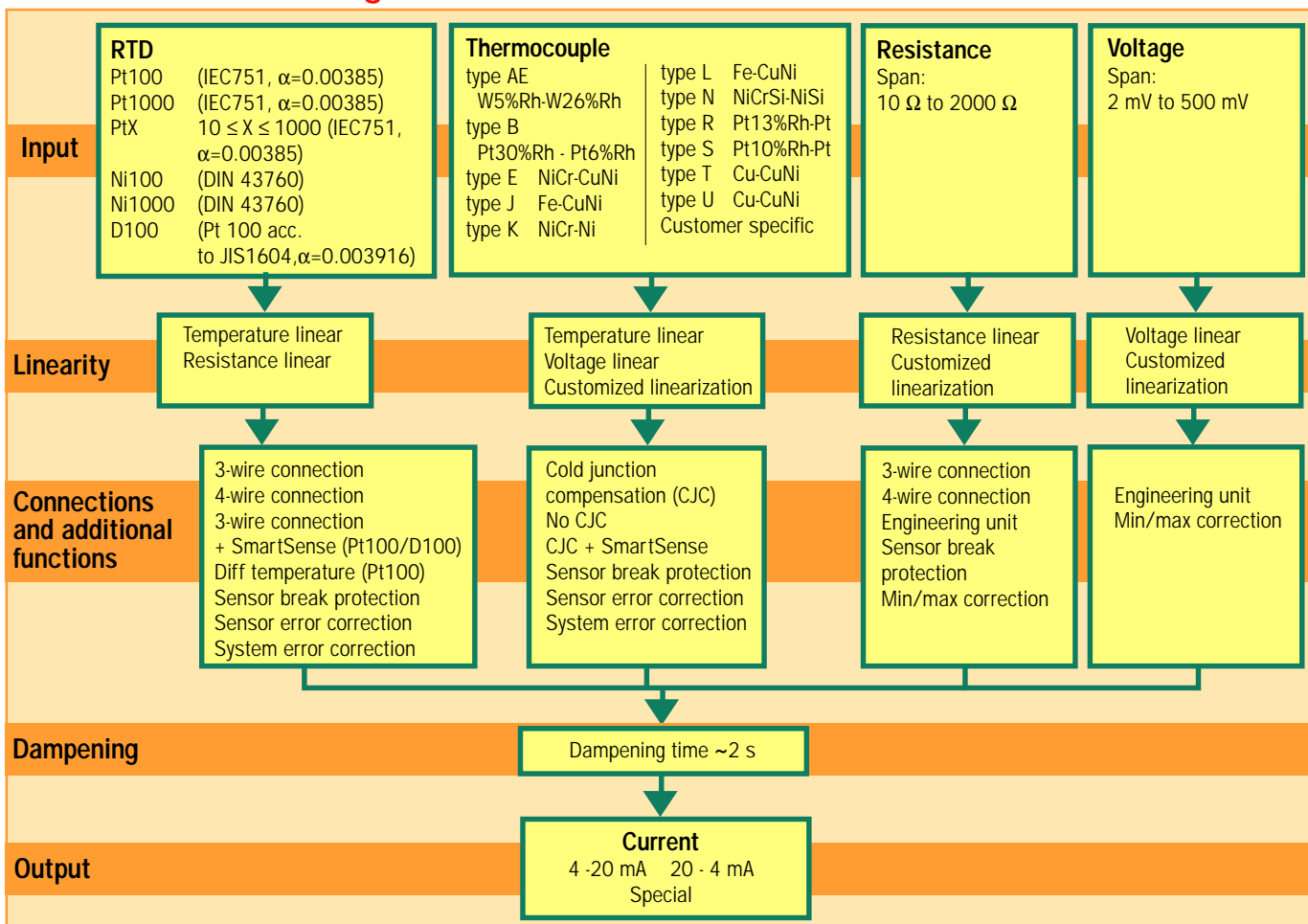

## Specifications

<b>Input</b>		
<b>RTD's and Resistance</b>		
Pt100 (IEC751, $\alpha = 0.00385$ )	3-, 4-wire connection	-200 to +1000 °C / -328 to +1832 °F
Pt1000 (IEC751, $\alpha = 0.00385$ )	3-, 4-wire connection	-200 to +200 °C / -328 to +392 °F
PtX $10 \leq X \leq 1000$ (IEC751, $\alpha = 0.00385$ )	3-, 4-wire connection	Upper range depending on X-value
Ni100 (DIN 43760)	3-, 4-wire connection	-60 to +250 °C / -76 to +482 °F
Ni1000 (DIN 43760)	3-, 4-wire connection	-60 to +150 °C / -76 to +302 °F
D100 (Pt 100 acc.to JIS1604, $\alpha = 0.003916$ )	3-, 4-wire connection	-200 to +1000 °C / -328 to +1832 °F
Potentiometer/resistance	3-, 4-wire connection	0 to 2000 $\Omega$
Sensor current		~ 0.4 mA
Maximum sensor wire resistance		25 $\Omega$ /wire
<b>Thermocouples and Voltage</b>		
T/C	Type: AE, B, E, J, K, L, N, R, S, T, U	Ranges according to users manual
Voltage input		-10 to +500 mV
Input impedance		>10 M $\Omega$
Maximum sensor wire resistance		500 $\Omega$ (total loop)
<b>Monitoring</b>		
Sensor break monitoring	User definable output	3.5 to 21.6 mA
SmartSense, sensor isolation monitoring	User definable output	3.5 to 21.6 mA
<b>Adjustments</b>		
Zero adjustment	All inputs	Any value within range limits
Minimum spans	Pt100, Pt1000, Ni100, Ni1000	10 °C / 18 °F
	Potentiometer	10 $\Omega$
	T/C, mV	2 mV
<b>Output</b>		
Straight, reversed or any intermediate value		4-20/20-4 mA
Resolution		5 $\mu$ A
Minimum output signal	Measurement/Failure	3.8 mA / 3.5 mA
Maximum output signal	Measurement/Failure	20.5 mA / 21.6 mA
Permissible load, <i>see fig.6</i>	IPAQ-H	795 $\Omega$ @ 24 VDC, 22 mA
	IPAQ-HX	725 $\Omega$ @ 24 VDC, 22 mA
<b>Temperature</b>		
Ambient, storage		-40 to +85 °C / -40 to +185 °F
Ambient, operation	IPAQ-H	-40 to +85 °C / -40 to +185 °F
	IPAQ-HX	See Intrinsic Safety specifications
<b>General data</b>		
Selectable dampening time		~ 2 s
Update time		~ 1.5 s
Isolation In - Out	Isolated version	1500 VAC, 1 min
Humidity (non-condensing)		0 to 95 %RH
Intrinsic safety	IPAQ-HX, Cenelec	EEx ia IIC T4, T5, T6
	FM	Class I, Div. 1, Group A-D, T4
<b>Power supply, polarity protected</b>		
Supply voltage	IPAQ-H	6.5 to 36 VDC 2-wire
	IPAQ-HX	8.0 to 30 VDC 2-wire
Permissible ripple		4 V p-p @ 50/60 Hz

<b>Accuracy</b>		
Linearity	RTD Potentiometer, mV	±0.1 % <sup>1)</sup>
	T/C	±0.2 % <sup>1)</sup>
Calibration	RTD	Max. of ±0.2 °C / ±0.4 °F or ±0.1 % <sup>1)</sup>
	Potentiometer	Max. of ±0.1 Ω or ±0.1 % <sup>1)</sup>
	mV, T/C	Max. of ±20 μV or ±0.1 % <sup>1)</sup>
Cold Junction Compensation (CJC)	T/C	±0.5 °C / ±0.9 °F
Temperature influence <sup>4)</sup>	All inputs	Max. of ±0.25 °C/25 °C or ±0.25%/25 °C <sup>1) 3)</sup>
		Max. of ±0.5 °F/50 °F or ±0.28%/50 °F <sup>1) 3)</sup>
Temperature influence CJC <sup>4)</sup>	T/C	±0.5 °C/25 °C / ±1.0 °F/50 °F
Instrument calibration output	4-20 mA	±8 μA
Sensor wire resistance influence	RTD, Potentiometer, 3-wire	Negligible <sup>2)</sup>
	RTD, Potentiometer, 4-wire	Negligible
	mV, T/C	Negligible
Load influence		Negligible
Power supply influence		Negligible
RFI influence, 0.15 to 1000 MHz, 10 V or V/m		±0.1% <sup>1)</sup> (typical)
Long-term stability		±0.1 % <sup>1)</sup> /year
<b>Housing</b>		
Material / Flammability (UL)		PC + ABS/V0, Polyamide/V2
Mounting		DIN B-head or larger, DIN rail (with mounting kit)
Connection	Single/stranded wires	≤1.5 mm <sup>2</sup> , AWG 16
Weight		50 g
Protection, housing / terminals		IP 50 / IP 10

<sup>1)</sup> Of input span

<sup>2)</sup> With equal wire resistance

<sup>3)</sup> If zero-deflection > 100% of input span:  
add 0.125% of input span/25 °C or 0.14%  
of input span/50 °F per 100% zero-deflection

<sup>4)</sup> Reference temperature 23 °C / 73°F

**The User Instructions must be read prior to adjustment and/or installation.**

## Intrinsic Safety specifications

Specifications	IPAQ-HX, isolated and non-isolated	IPAQ-HX, isolated
<b>Approval</b>	Demko / Cenelec	Factory Mutual (FM)
<b>Classification</b>	EEx ia IIC T4, T5, T6	IS for use in Class I, Div. 1,
	T4/+85°C, T5/+65°C, T6/+50°C	Group A-D, T4/+80°C
<b>Certificate No.</b>	95D.117989X	J.I. OD6A8.AX, Drw. 3-7851
<b>Output/Supply</b>		
Max voltage to transmitter	U <sub>i</sub> = 30 Vdc	V <sub>max</sub> = 30 Vdc
Max current to transmitter	I <sub>i</sub> = 100 mA	I <sub>max</sub> = 100 mA
Max power to transmitter	P <sub>i</sub> = 900 mW	P <sub>max</sub> = 900 mW
Internal inductance	L <sub>i</sub> = 0 mH	L <sub>i</sub> = 2.5 mH
Internal capacitance	C <sub>i</sub> = 0 μF	C <sub>i</sub> = 0 μF
<b>Input (Sensor)</b>		
Max voltage from transmitter	U <sub>o</sub> = 30 Vdc	V <sub>oc</sub> = 30 Vdc
Max current from transmitter	I <sub>o</sub> = 25 mA	I <sub>sc</sub> = 25 mA
Max power from transmitter	P <sub>o</sub> = 188 mW	Not specified
Max inductance (input loop)	L <sub>o</sub> = 50 mH	L <sub>a</sub> = 56.8 mH
Max capacitance (input loop)	C <sub>o</sub> = 66 nF	C <sub>a</sub> = 0.12 μF

INPUTS

RTD

Pt100, Pt1000, Ni100, Ni1000, PtX, D100  
4-wire connection

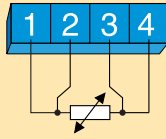

3-wire connection

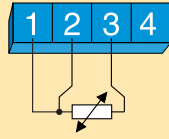

Pt100, D100  
3-wire connection

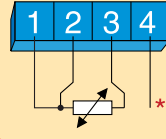

\* SmartSense lead

Pt100  
Diff temperature  $T_1 > T_2$

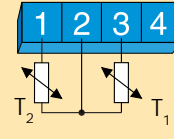

Potentiometer

4-wire connection

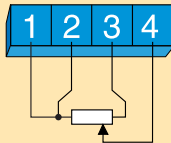

3-wire connection

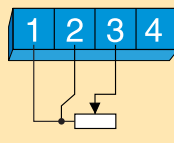

Voltage

millivolt

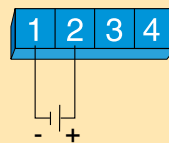

Thermocouple

AE, B, E, J, K, L, N, R, S, T, U  
or customer specific

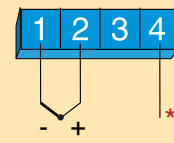

\* SmartSense lead

OUTPUT

4-20 mA Output

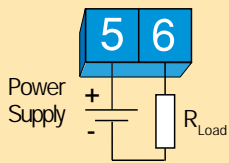

Connections

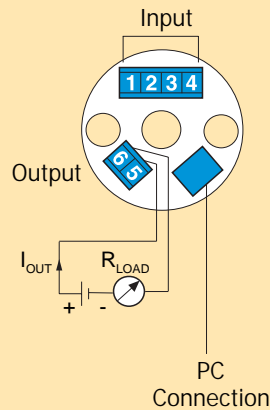

Dimensions

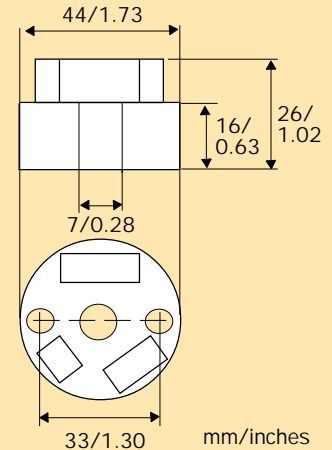

SmartSense

Fig.5

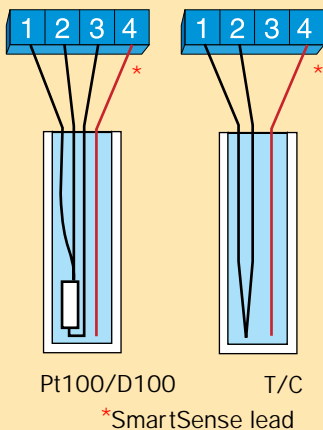

\* SmartSense lead

Output load diagram

Fig.6

Permissible  $R_{Load}$  at 22 mA output

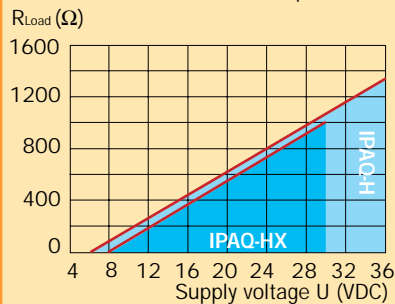

$$R_{Load} = (U - 6.5) / 0.022 \quad (\text{IPAQ-H})$$

$$R_{Load} = (U - 8) / 0.022 \quad (\text{IPAQ-HX})$$

Ordering table

Item	Part No.
<b>Transmitter</b>	
IPAQ-H, isolated	70IPH00001
IPAQ-H, non-isolated	70IPH00002
IPAQ-HX, isolated (Cenelec)	70IPHX0001
IPAQ-HX, non-isolated (Cenelec)	70IPHX0002
IPAQ-HX, isolated (FM)	70IPHX1001
<b>Options</b>	
Configuration	70CAL00001
Configuration with 5-point calibration certificate	70CAL00051
<b>Software and cable</b>	
IPRO-X (IPRO with cable)	70IPRX0001
Software IPRO upgrade	70IPRS0001
<b>Accessories</b>	
Surface mounting box	70ADA00008
Rail mounting box	70ADA00009
Head mounting kit	70ADA00012
Rail mounting kit	70ADA00013

**DEMKO**  
Testing and Certification



**CERTIFICATE OF CONFORMITY**

1. DEMKO No. **95D.11798X**

2. This certificate is issued for **Two-wire Infrared Transmitter**

type **IPAQ-HX**

3.1. Classes (E): **TS.8**

4. Manufactured by **DMOR AB**  
PO Box 9021, S-200 39 Malmö  
Sweden

4b. and submitted by **the Manufacturer**

5. This electrical apparatus and any acceptable variation thereto is specified in the Appendix to this certificate and the documents therein referred to.

6. DEMKO being an Approved Certification Body in accordance with Article 14 of the Council Directive of 06 February 1975, document 79/106/EEC. A facsimile of this mark is printed at the top of this certificate. The marking of the equipment shall be visible, legible and durable.

**EN 50024** incl. amend. 1 - 3  
**EN 50026** incl. amend. 1 - 3

7. The apparatus marking shall include the code **EM in EC-TS-TR**

8. The supplier of the electrical apparatus referred to in this certificate has the responsibility to ensure that the apparatus conforms to the specification laid down in the Appendix to this certificate and has satisfied routine verifications and tests specified therein.

9. The apparatus may be marked with the Directive Community Mark specified in Annex II to the Council Directive of 06 February 1975, document 79/106/EEC. A facsimile of this mark is printed at the top of this certificate. The marking of the equipment shall be visible, legible and durable.

Date **1993-06-29** Signature 

The certificate is only valid if it is marked in original and without alteration.

**DEMKO** Luleå, Sweden Tel: +46 (0)90 12 10 00 Fax: +46 (0)90 12 10 01  
S-200 39 Malmö, Sweden Tel: +46 (0)40 33 00 00 Fax: +46 (0)40 33 00 00

**DEMKO**  
Testing and Certification

Luleå, S-101 80 214  
OK1730 Luleå, Denmark  
Phone: +46 (0)90 12 10 00  
Fax: +46 (0)90 12 10 01

DMOR AB  
Box 5125  
S-200 39 Malmö  
Sweden

Name: **Klas Håren**

For approval: **Lars Carlsson** 1993-03-03 For info: - For the customer: **11798D XME** 254 Date: **1996-02-29**

**APPENDIX II**  
to Certificate of Conformity No. 95D.11798X

**Approval**

DEMKO hereby grants approval of the following:

Two-wire Infrared Transmitter  
modelled with silicon  
supply 4-20 mA current loop  
marked "EMEC"  
E1 type IPAQ-HX  
area manufacture  
protected for use in potentially  
explosive atmosphere (intrinsically safe)  
EM in EC-TS-TR

The product type has been tested in accordance with the Heavy Current Regulations, Section 39 (EN 50024 incl. amend. 1 - 3) and 39-6 (EN 50026 incl. amend. 1 - 3).

The approval applies to products, exactly identical with the submitted and approved product type. If you make any alteration of the product, including the marking, you are obliged to inform DEMKO about this by letter.

**Further Conditions Relating to the Approval**

The equipment must be electrically connected via an approved or certified isolating inter-connection device placed outside the hazardous area.

The product has been approved for the below mentioned ambient temperature ranges in the following temperature classes:

TS for ambient temperature:  $-40\text{ °C} < T_{amb} < +40\text{ °C}$   
TS for ambient temperature:  $-40\text{ °C} < T_{amb} < +40\text{ °C}$   
TS for ambient temperature:  $-40\text{ °C} < T_{amb} < +40\text{ °C}$

KME/17 41,330

**DEMKO**

Ref. No. 11798D XME - 2 - 1996-02-29

**Internally Safe Specifications**

Output: (Current Loop)

$U_o$  = 30 VDC  
 $I_o$  = 100 mA  
 $P_o$  = 8.0 W  
 $L_o$  = 0 mH  
 $C_o$  = 0  $\mu$ F

Input: (Source)

$U_i$  = 30 VDC  
 $I_i$  = 25 mA  
 $P_i$  = 18 mW  
 $L_i$  = 30 mH  
 $C_i$  = 46  $\mu$ F

by which

$U_o$  Maximum voltage that can be applied to the connection facilities for intrinsically safe circuits without invalidating intrinsic safety.

$I_o$  Maximum current that can be applied to the connection facilities for intrinsically safe circuits without invalidating intrinsic safety.

$P_o$  Maximum power that can be applied to the connection facilities for intrinsically safe circuits without invalidating intrinsic safety.

$L_o$  Total equivalent inductance of the apparatus which is considered as appearing at the connection facilities of the apparatus.

$C_o$  Total equivalent internal capacitance of the apparatus which is considered as appearing across the connection facilities of the apparatus.

$U_i$  Maximum output voltage in an intrinsically safe circuit that can appear under open circuit conditions at the connection facilities of the apparatus at any applied voltage up to the maximum voltage, including  $U_o$  and  $U_i$ .

$I_i$  Maximum current in an intrinsically safe circuit that can be taken from the connection facilities of the apparatus.

$P_i$  Maximum power in an intrinsically safe circuit that can be taken from the connection facilities of the apparatus.

$L_i$  Maximum value of inductance in an intrinsically safe circuit that can be connected to the connection facilities of the apparatus without invalidating intrinsic safety.

$C_i$  Maximum capacitance in an intrinsically safe circuit that can be connected to the connection facilities of the apparatus without invalidating intrinsic safety.

**DEMKO**

Ref. No. 11798D XME - 3 - 1996-02-29

**Drawings**

TITLE	DRAWING NO.	DATE
Description	5-7429 (3 pages)	950800
List of Components	5-7430-A	950808
Isolation with high voltage test	5-7500	950800
Temperature rate for SOT-23	5-7431	950800
Assembly	4-7428	950800
Block diagram	4-7435	950800
Diagram, overview	4-7347 rev. A	940909
Diagram, input	3-7348 rev. D	950112
Diagram, CPU	3-7349 rev. D	950600
Diagram, output	3-7350 rev. C	950600
EMEC location primary side	4-7350 rev. A	950126
EMEC location primary side	4-7352 rev. A	950126
Print layout layer 1	4-7360 rev. A	950126
Print layout layer 2	4-7359 rev. A	950126
Print layout layer 3	4-7327 rev. A (2/2)	950126
Print layout layer 3	4-7328 rev. A (2/2)	950126
Print layout layer 4	4-7326 rev. A	950126
EMEC location secondary side	4-7324 rev. A	950126
EMEC location secondary side	4-7323 rev. A	950126
Label	4-7432	950800
EMC label	4-7433-A	950800

The approval entitles the licensee to provide the product with the registered approval mark  and the licensee's mark.

This APPENDIX II replaces earlier issued APPENDIX II dated 1993-06-29, and shall be used with Certificate of Conformity no. 95D.11798X dated 1993-06-29.

Yours faithfully  
**DEMKO**

  
M. S. Nilsson  
Head of Dept.

**CERTIFICATE OF COMPLIANCE**

**HAZARDOUS (CLASSIFIED) LOCATION ELECTRICAL EQUIPMENT**

This certificate is issued for the following equipment:

**4-20 mA TEMPERATURE TRANSMITTER** consisting of the following apparatus, installed in accordance with entry requirements and Certification Drawings 3-7852, 3-7851 and 3-7853. The transmitters were constructed having the following equipment ratings:

Associated electrical apparatus having intrinsically safe connections for Class I, II and III, Division I, Group A, B, C, D and G hazardous (classified) locations.

**Apparatus Model**  
 Temperature Transmitter Model IPAQ-LX

Electrical apparatus having intrinsically safe connections for Class I, Division I, Group A, B, C and D hazardous (classified) locations.

**Apparatus Type**  
 Temperature Transmitter Model IPAQ-HX  
 Temperature Transmitter Model APAQ-HX

Manufactured by: INOR PROCESS AB  
 P.O. BOX 8123  
 S-200 76 MALMO, SWEDEN

This certifies that the equipment described has been found to comply with the following Factory Mutual Research Corporation Approval Standards:

- Approval Standard Class 3608 - 1988
- Approval Standard Class 3613 - 1988
- Approval Standard Class 3614 - 1988

Approval Job Identification: 82648-AX Approval Report Dated August 6, 1997

Factory Mutual Research Corporation  
  
 Frank J. Murphy, Manager  
 Intrinsically Safe Section  
 Approval Division

Date: 9/19/97

**4.2 Listing**

1.2.1 The following was evaluated as associated apparatus having intrinsically safe connections for Class I, II, III, Division I, Group A, B, C, D, E, F and G, hazardous (classified) locations in accordance with Drawing No. 3-7852, Revision F, and will appear in the Approval Guide as follows:

**APPROVED - 3-7852 / F, Entry**

Entry Parameters (Terminals 3 and 4):  
 Vmax = 30 V, Imax = 180 mA, Pmax = 900 mW, Ci and Li are not applicable.

Entry Parameters (Terminals 1, 2, 3 and 4):  
 Voc = 30 V, Isc = 25 mA, Ca = 8.12 uF, La = 56.8 mH

Temperature Transmitter, Model IPAQ-LX

1.2.2 The following was evaluated as intrinsically safe for use in Class I, Division I, Groups A, B, C and D hazardous (classified) locations in accordance with entry requirements and Drawing No. 3-7851, Revision F and will appear in the Approval Guide as follows:

**APPROVED - 3-7851 / F, Entry**

Entry Parameters (Terminals 3 and 4):  
 Vmax = 30 V, Imax = 180 mA, Pmax = 900 mW, Ci = 0, Li = 2.5 uH

Entry Parameters (Terminals 1, 2, 3 and 4):  
 Voc = 30 V, Isc = 25 mA, Ca = 8.12 uF, La = 56.8 mH

Temperature Transmitter, Model IPAQ-HX

1.2.3 The following was evaluated as intrinsically safe for use in Class I, Division I, Groups A, B, C and D hazardous (classified) locations in accordance with entry requirements and Drawing No. 3-7853, Revision C and will appear in the Approval Guide as follows:

**APPROVED - 3-7853 / C, Entry**

Entry Parameters (Terminals 4 and 5):  
 Vmax = 30 V, Imax = 100 mA, Pmax = 780 mW, Ci = 0.018 uF, Li = 0

Entry Parameters (Terminals 1, 2 and 3):  
 Voc = 30 V, Isc = 96.7 mA, Ca = 0.12 uF, La = 5.86 mH

Temperature Transmitter, Model APAQ-HX

