

**NOTE : MINIMUM DISTANCE BETWEEN FLOATS IS 75mm**

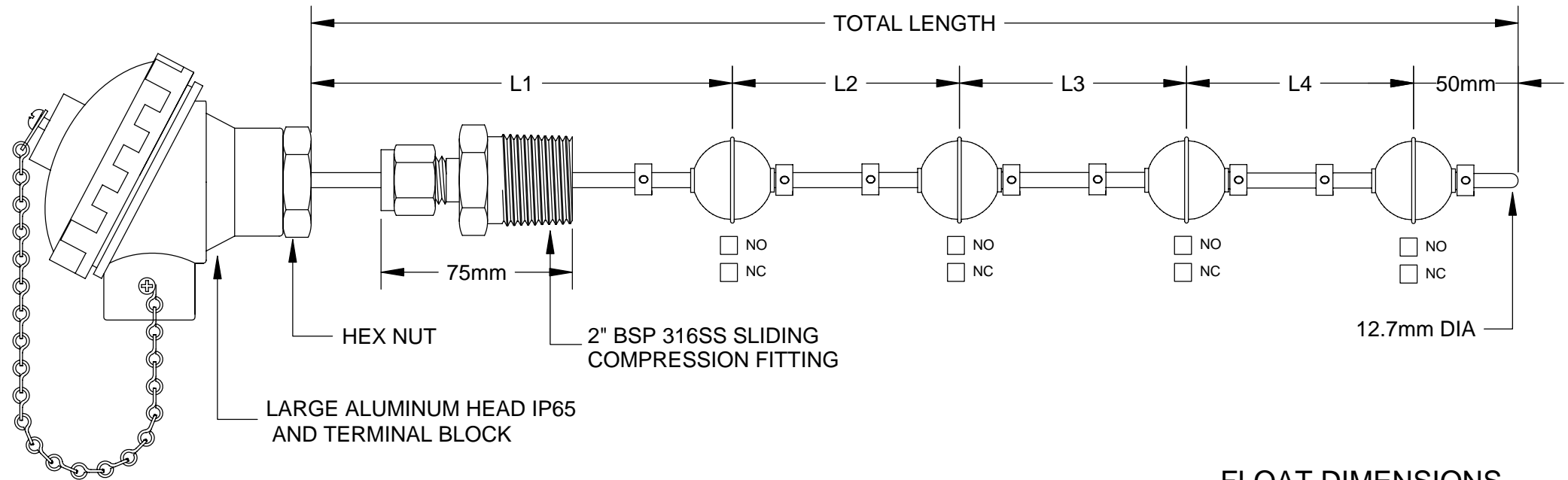

- STANDARD - NO or NC CONTACT RATED AT 32V AC/DC @ 500mA RESISTIVE LOAD
- OPTION - NO or NC CONTACT RATED AT 250V AC/DC @ 500mA RESISTIVE LOAD
- INDIVIDUALLY WIRED CONTACTS
- COMMON WIRED CONTACTS
- CHANGE OVER CONTACT RATED @ 250mA RESISTIVE LOAD

**FLOAT DIMENSIONS**

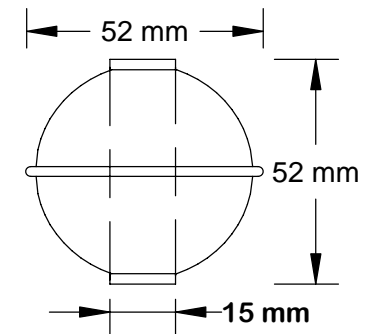

**PROCESS CAPABILITIES**

- STAINLESS STEEL CONSTRUCTION
- UP TO 5 FLOATS PER ASSEMBLY MAXIMUM LENGTH 2000mm
- INDIVIDUAL OR COMMON CIRCUIT WIRING
- SPECIAL THREADS AND LENGTHS AVAILABLE
- SPECIFIC GRAVITY 0.55
- TEMPERATURE RATING 120'C MAXIMUM
- PRESSURE RATING :30 kg/cm2 MAXIMUM
- SCREW IN MULTI -LEVEL ASSEMBLY
- 52mm DIAMETER 316 STAINLESS STEEL FLOAT

**TEMPERATURE CONTROLS PTY LTD** Certificate No:QEC 14412  
AS/NZS 9001:2000

**CONDITIONS**

THIS DRAWING IS OUR EXCLUSIVE PROPERTY AND MUST NOT BE COPIED OR HANDED TO ANY OTHER PARTIES WITH OUT WRITTEN PERMISSION. IT SHALL BE RETURNED UPON REQUEST

SYDNEY : 7 YAMMA ST SEFTON , NSW 2162  
PHONE : (02) 9721 8644 FAX : (02) 9738 9339  
MELBOURNE : 8/280 Whitehall St  
YARRAVILLE VIC 3013  
PHONE : (03) 9687 0000 FAX : (03) 9687 1900  
EMAIL : sales@temperature.com.au



TITLE

SIZE : A4	DATE : 03/07/08	DWG NO :SD 462
SCALE : NTS	DRAWING BY K.F	REV : 01