

TEMPCO 307K- HAND HELD DIGITAL THERMOMETER SINGLE & DIFFERENTIAL TEMPERATURE MEASUREMENT

This instrument is a hand held portable digital thermometer designed to use Type K thermocouples with connection via industry standard mini plug. SPECIFICATIONS

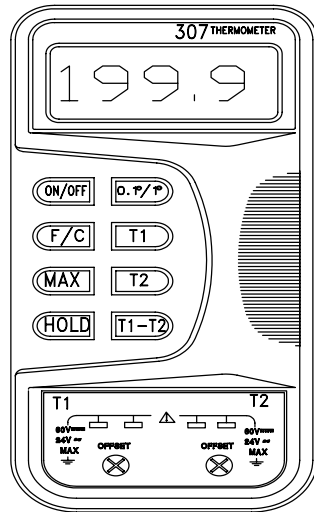

- Measurement range
-50 ° C to 1300 ° C
- Single Reading T1
- Single Reading T2
- Differential Reading T1-T2
- Resolution
1° C to 1300° C
- Reading Rate
2.5 times per second
- Accuracy
+/- (0.3% + 1° C) -50° - 1000° C
+/- (0.5% + 1° C) 1000° - 1300° C
- Maximum value display
- Hold Value Display
- Offset adjustment for calibration
- Celsius or Fahrenheit readings
- Battery Life typical 200hr
- Probes made to suit your application

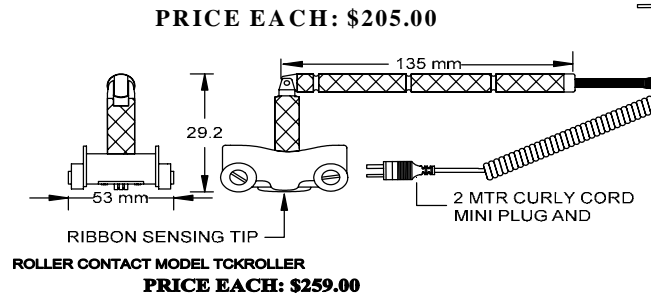
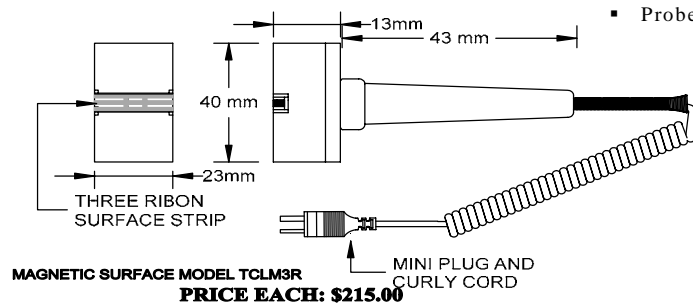
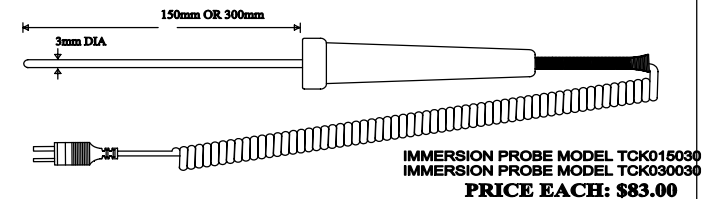
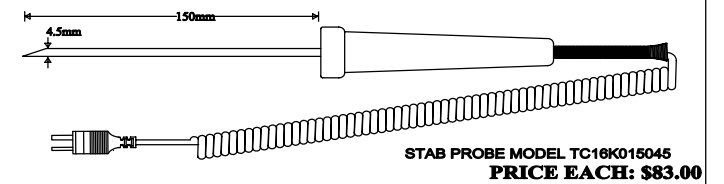
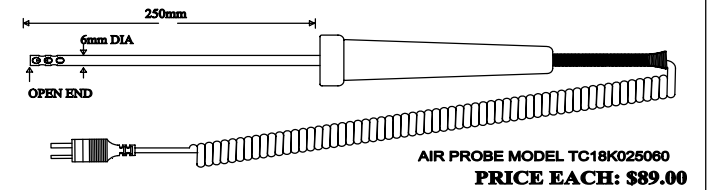
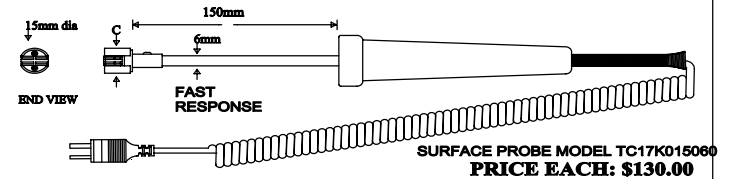

TEMPERATURE CONTROLS PTY LTD		Certificate No: QEC 14412 AS/NZS 9001:2000
CONDITIONS THIS DRAWING IS OUR EXCLUSIVE PROPERTY AND MUST NOT BE COPIED OR HANDED TO ANY OTHER PARTIES WITH OUT WRITTEN PERMISSION. IT SHALL BE RETURNED UPON REQUEST		
SYDNEY : 7 YAMMA ST SEFTON , NSW 2162 PHONE : (02) 9721 8044 FAX : (02) 9738 9339 MELBOURNE : 8/280 Whitehall St YARRAVILLE VIC 3013 PHONE : (03) 9887 0000 FAX : (03) 9887 1900 EMAIL : sales@temperature.com.au		
TITLE LITERATURE NO. 1359		
SIZE : A4	DATE : 8/09/06	
SCALE : NTS	DRAWING BY K.F	REV : 00

TEMPCO 305K - HAND HELD DIGITAL THERMOMETER

This instrument is a hand held portable digital thermometer designed to use Type K thermocouples with connection via industry standard mini plug.

SPECIFICATIONS

- Measurement range
-50 ° C to 1300 ° C
- Resolution
0.1° C 0 to 199.9° C
1° C to 1300° C
- Reading Rate
2.5 times per second
- Accuracy
+/- (0.3% + 1° C) -50° - 1000° C
+/- (0.5% + 1° C) 1000° - 1300° C
- Maximum value display
- Hold Value Display
- Offset adjustment for calibration
- Celsius or Fahrenheit readings
- Battery Life typical 200hr
- Probes made to suit your application

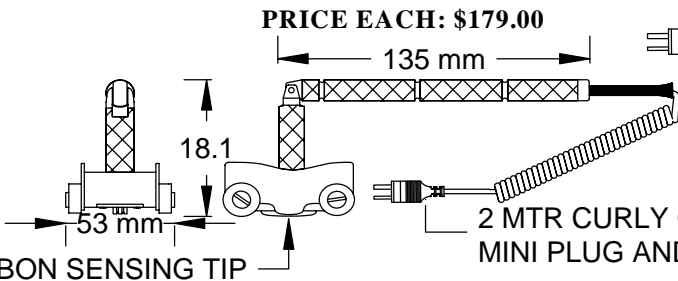
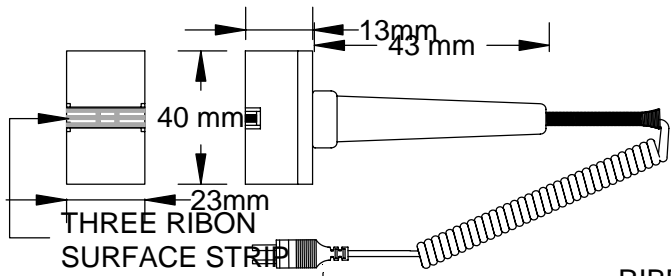
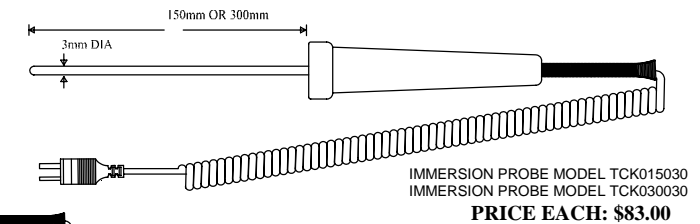
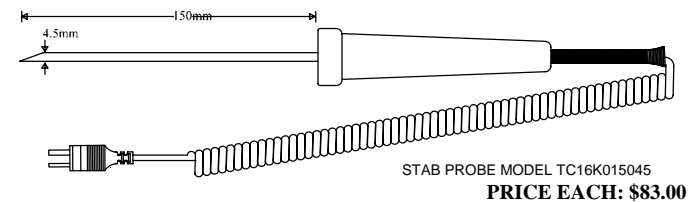
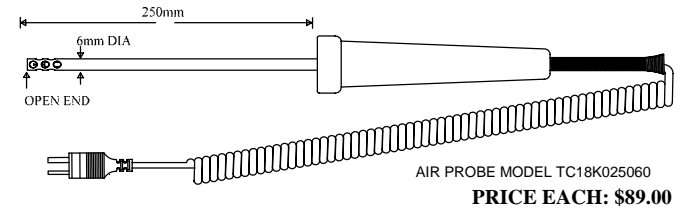
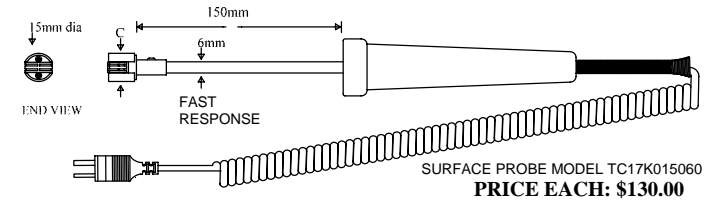
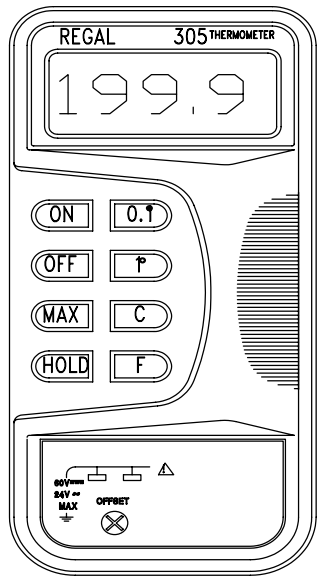

MAGNETIC SURFACE MODEL TCLM3R

PRICE EACH: \$215.00

MINI PLUG AND
CURLY CORD

ROLLER CONTACT MODEL TCKROLLER

PRICE EACH: \$259.00

TEMPERATURE CONTROLS PTY LTD		Certificate No: QEC 14412 AS/NZS 9001:2000	
CONDITIONS		SYDNEY : 7 YAMMA ST SEFTON, NSW 2162 PHONE : (02) 9721 8644 FAX : (02) 9738 9339	
THIS DRAWING IS OUR EXCLUSIVE PROPERTY AND MUST NOT BE COPIED OR HANDED TO ANY OTHER PARTIES WITH OUT WRITTEN PERMISSION. IT SHALL BE RETURNED UPON REQUEST		MELBOURNE : 8/280 Whitehall St YARRAVILLE VIC 3013 PHONE : (03) 9687 0000 FAX: (03) 9687 1900 EMAIL : sales@temperature.com.au	
			
TITLE LITERATURE NO. 1024			
SIZE : A4	DATE :		
SCALE : NTS	DRAWING BY K.F	REV : 01	